



INCA GLOBAL

Aluminium Pergola Systems
Catalog

✉ EMAIL

info@incaglobal.com.tr

☎ TELEPHONE

+90 535 977 84 91

🌐 WEBSITE

www.incaglobal.com.tr

- 10-10415
- Oluk Profili/Gutter Profile
- 3.383 kg/m

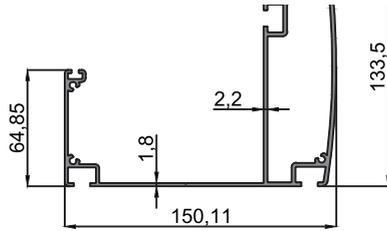

- 10-10468
- Oluk Profili/Gutter Profile
- 4.006 kg/m

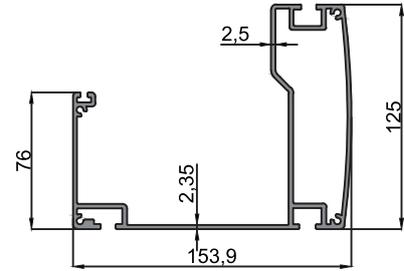

- 10-10477
- Oluk Profili/Gutter Profile
- 4.397 kg/m

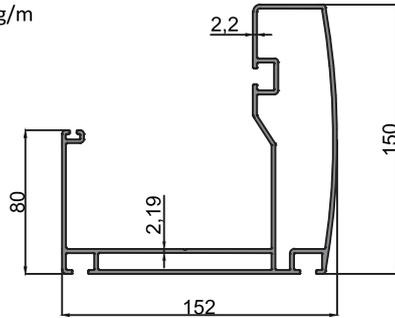

- 10-10512
- Oluk Profili/Gutter Profile
- 3.477 kg/m

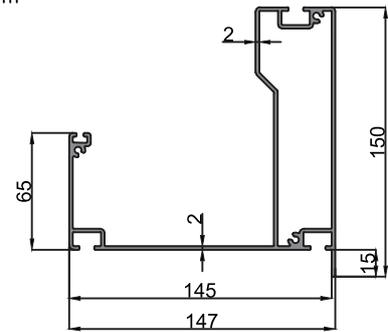

- 10-10412
- 70x150 mm Ray Profili/ 70x150 mm Rail Profile
- 3.094 kg/m

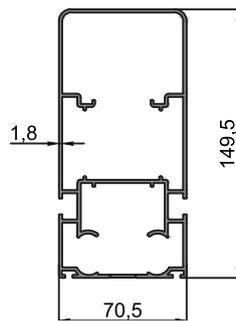

- 10-10413
- 70x150 mm Ray Profili/ 70x150 mm Rail Profile
- 4.994 kg/m

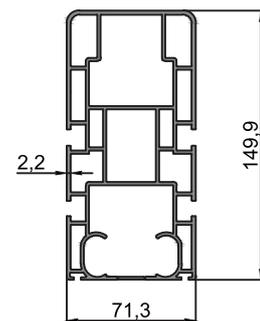

- 10-10469
- 70x150 mm Ray Profili/ 70x150 mm Rail Profile
- 4.196 kg/m

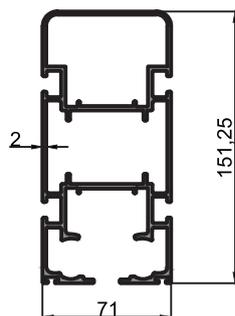

- 10-10411
- 90x150 Ray Profili/ 90x150 mm Rail Profile
- 5.114 kg/m

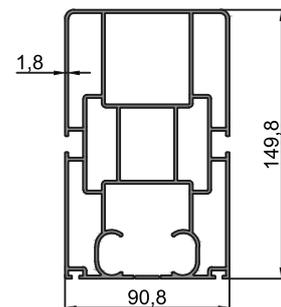

- 10-10501
- 90x150 Ray Profili/ 90x150 mm Rail Profile
- 4.129 kg/m

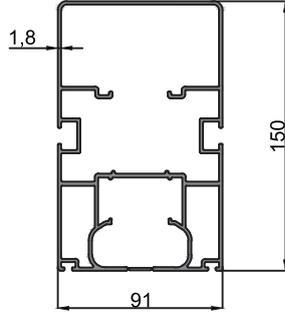

- 10-10475
- 110x150 mm Ray Profili/ 110x150 mm Rail Profile
- 7.170 kg/m

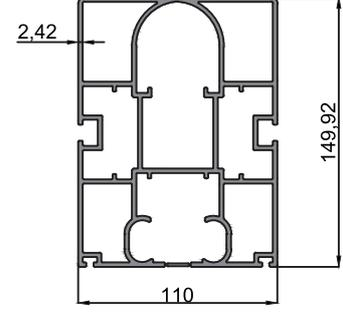

- 10-10414
- 100'lük Ayak Profili/ Counterfort Profile
- 2.227 kg/m

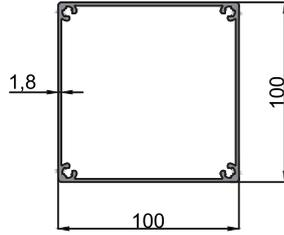

- 10-10419
- 144'lük Ayak Profili/ Counterfort Profile
- 2.927 kg/m

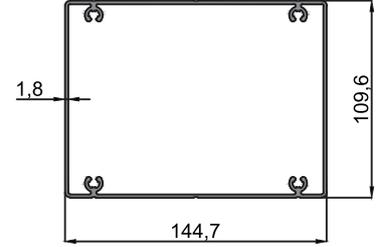

- 10-10416
- Kalın Korniş Profili/ Thick Stringcourse Profile
- 1.288 kg/m

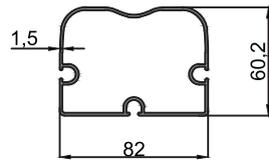

- 10-10418
- İnce Korniş Profili/ Thin Stringcourse Profile
- 0.737 kg/m

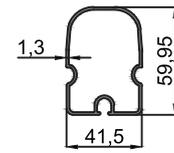

- 10-10472
- Kalın Korniş Profili/ Thick Stringcourse Profile
- 1.491 kg/m

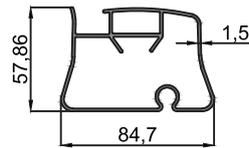

- 10-10471
- İnce Korniş Profili/ Thin Stringcourse Profile
- 0.809 kg/m

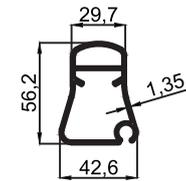

- 10-10470
- İnce Korniş Ek Profili/ Thin Stringcourse Joint Profile
- 0.590 kg/m

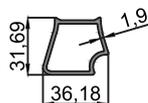

- 10-10420
- Orta Kayıt Profili/ Vertical Meeting Profile
- 1.355 kg/m

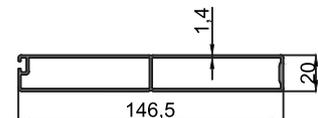

- 10-10417
- Tambur Boru Profili/Bull Block Tube Profile
- 1.071 kg/m

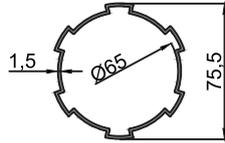

- 10-10467
- Tambur Boru Profili/Bull Block Tube Profile
- 1.213 kg/m

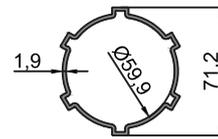

- 43-5209
- Korniş Profili/ Cornice Profile
- 0.791 kg/m

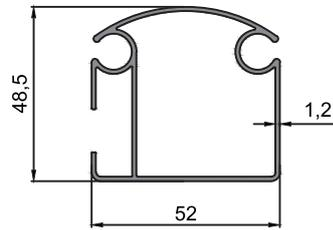

- 43-5211
- Korniş Profili/ Cornice Profile
- 0.214 kg/m

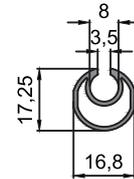

- 10-10911
- Alt Oluk Profili / Bottom Gutter Profile
- 3.015 kg/m

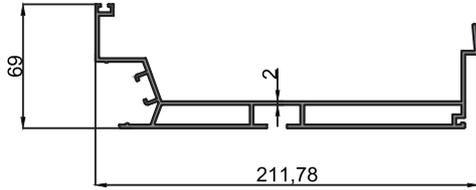

- 10-10910
- Yan Oluk Profili / Side Gutter Profile
- 3.562 kg/m

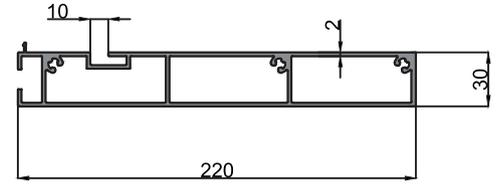

- 10-10909
- Oluk Ek Profili / Gutter Joint Profile
- 0.746 kg/m

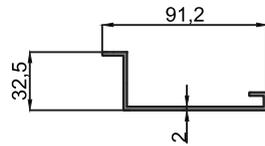

- 10-10921
- Panel Profili / Panel Profile
- 2.898 kg/m

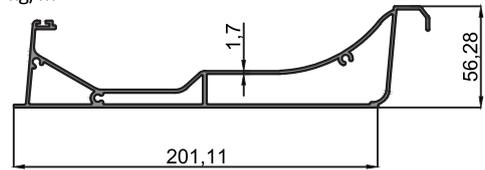

- 10-10974
- Hareketli Ray Profili / Moving Rail Profile
- 1.493 kg/m

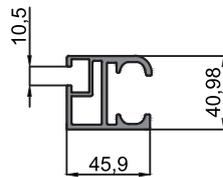

- 10-10943
- Sabit Ray Profili / Stable Rail Profile
- 4.578 kg/m

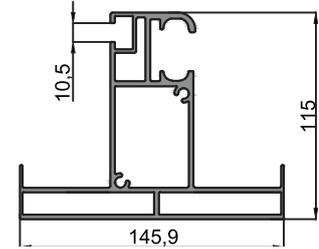

- 10-10913
- Sabit Ray Profili / Stable Rail Profile
- 3.056 kg/m

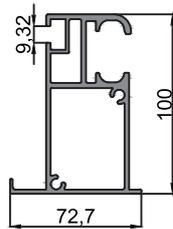

- 01-1462
- Ayak Profili / Counterfort Profile
- 4.782 kg/m

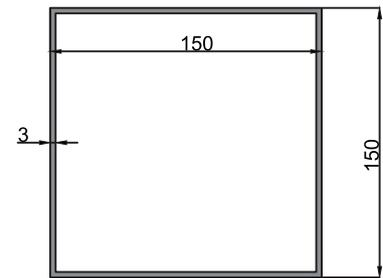

- 10-10941
- Ayak Kapak Profili / Counterfort Cover Profile
- 0.951 kg/m

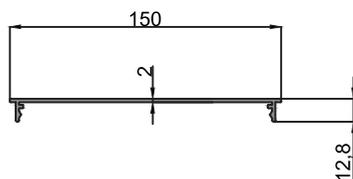

- 10-10942
- Ayak Profili / Counterfort Profile
- 3.841 kg/m

