



INCA GLOBAL

Aluminium Winter Garden
Systems Catalog



EMAIL
info@incaglobal.com.tr



TELEPHONE

+90 535 977 84 91



WEBSITE

www.incaglobal.com.tr

10-10094
Oluk Profili / Gutter Profile
4.849 kg/m

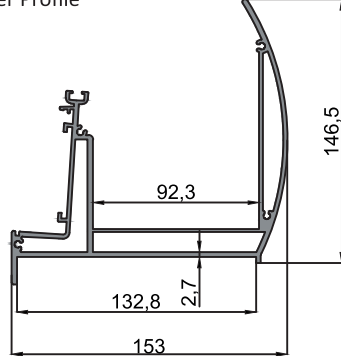

- 10-10281
- Oluk Profili / Gutter Profile
- 5.315 kg/m

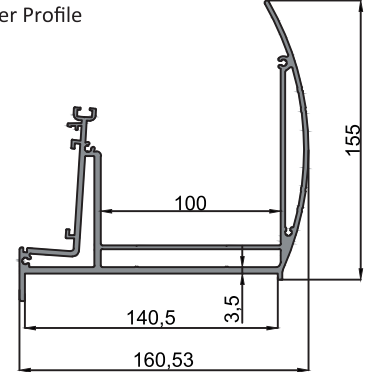

10-10093
Duvar Profili / Wall Profile
1.942 kg/m

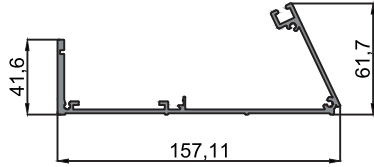

- 10-10285
- Duvar ve Oluk Profili İç Kapağı/Wall and Gutter Profile Inside Cover
- 0.577 kg/m

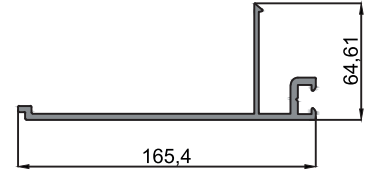

10-10284
Oluk Profili Dış Kapağı/Gutter Profile Outside Cover
1.402 kg/m

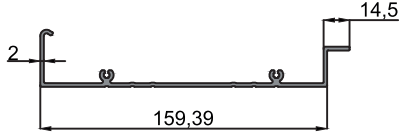

- 10-10097
- Polikarbon Taşıyıcı Profil/Polycarbonate Carrier Profile
- 1.851 kg/m

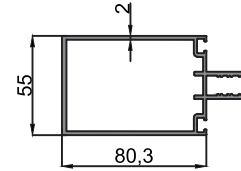

10-10098
Cam Taşıyıcı Profil/Glazing Carrier Profile
2.265 kg/m

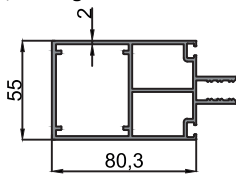

- 10-10099
- Taşıyıcı Profil Orta Kapağı / Carrier Profile Middle Cover
- 0,472 kg/m

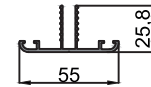

10-10100
Taşıyıcı Profil Yan Kapağı / Carrier Profile Side Cover
0.659 kg/m

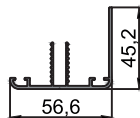

- 10-10101
- Kutu Profil / Rectangular Tube Profile
- 1.582 kg/m

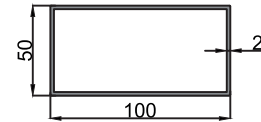

10-10091
Polikarbon Kapama Çıtasa Profili/Polycarbonate Cover Strip Profile
0.252 kg/m

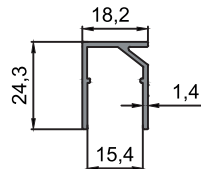

- 10-10090
- H Profil / H Profile
- 0.505 kg/m

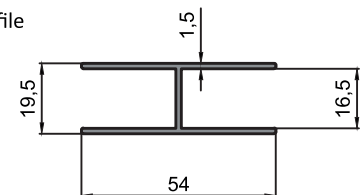

- 10-10095
- Ayak Profili / Counterfort Profile
- 2.046 kg/m

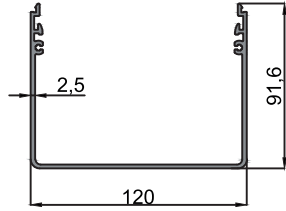

- 10-10096
- Ayak Kapak Profili / Counterfort Cover Profile
- 1.220 kg/m

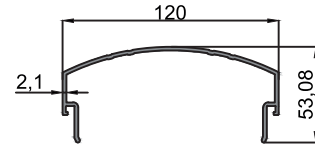

- 10-10282
- Ayak Profili / Counterfort Profile
- 4.038 kg/m

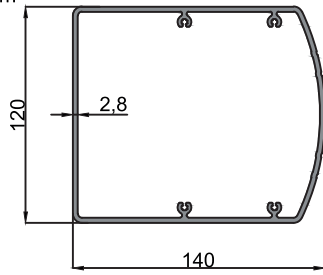

- 10-10283
- Ayak Profili / Counterfort Profile
- 4.237 kg/m

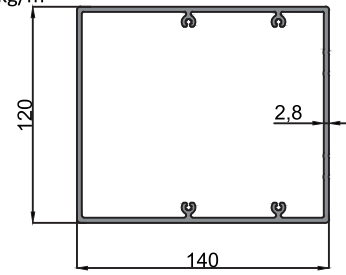

- 10-10291
- Duvar Destek Profili
Wall Back Up Profile
- 4.996 kg/m

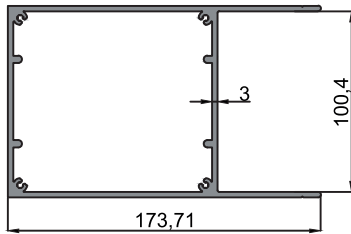

- 10-10522
- Oluk Profili E / Gutter Profile E
- 4.340 kg/m

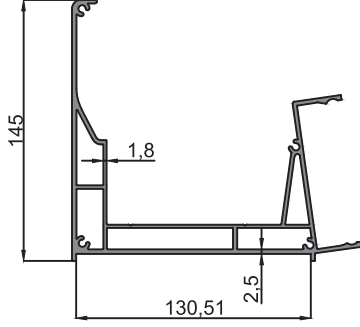

- Oluk Profili L / Gutter Profile L
- 6.780 kg/m

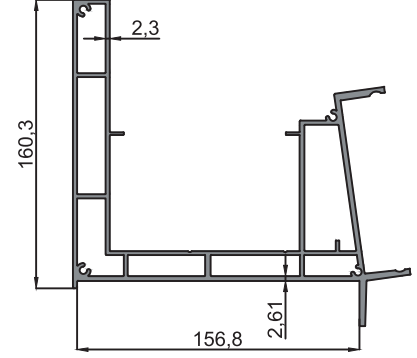

- 10-10537
- Duvar Profili E / Wall Profile E
- 2.250 kg/m

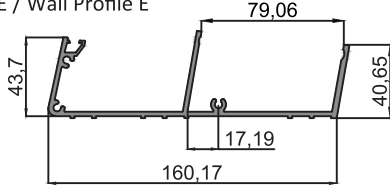

- 10-10528
- Duvar Profili L / Wall Profile L
- 2.252 kg/m

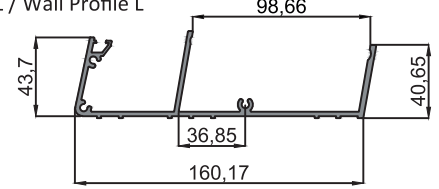

- 10-10536
- Duvar ve Oluk Profili İç Kapağı E / Wall and Gutter Profile Inside Cover E
- 0.506 kg/m

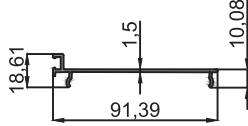

- 10-10529
- Duvar ve Oluk Profili İç Kapağı L / Wall and Gutter Profile Inside Cover L
- 0.585 kg/m

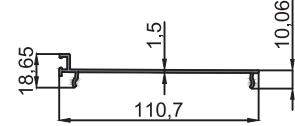

- 10-10535
- Polikarbon Taşıyıcı Profil E / Polycarbonate Carrier Profile E
- 1.782 kg/m

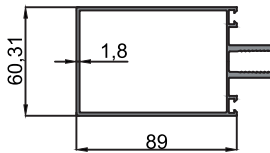

- 10-10525
- Polikarbon Taşıyıcı Profil L / Polycarbonate Carrier Profile L
- 1.965 kg/m

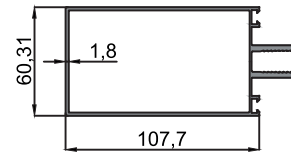

- 10-10534
- Cam Taşıyıcı Profil E / Glazing Carrier Profile E
- 2.691 kg/m

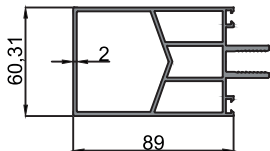

- 10-10524
- Cam Taşıyıcı Profil L / Glazing Carrier Profile L
- 2.914 kg/m

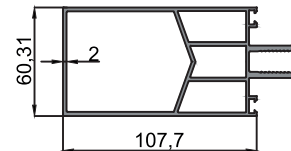

- 10-10526
- Taşıyıcı Profil Orta Kapağı E-L / Carrier Profile Middle Cover E-L
- 0.677 kg/m

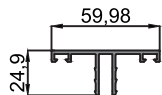

- 10-10527
- Taşıyıcı Profil Yan Kapağı E-L / Carrier Profile Side Cover E-L
- 0.870 kg/m

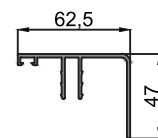

- 10-10523
- Ayak Profili E / Counterfort Profile E
- 3.901 kg/m

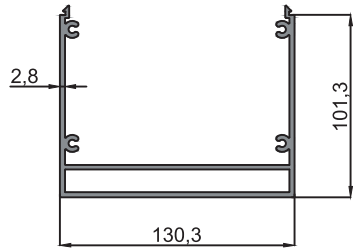

- 10-10542
- Ayak Profili L / Counterfort Profile L
- 4.608 kg/m

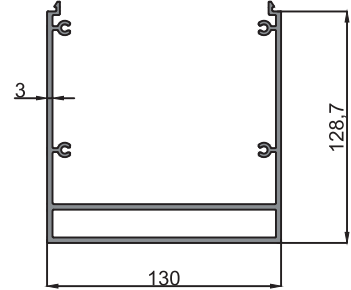

- 10-10532
- Ayak Kapak Profili E / Counterfort Cover Profile E
- 1.341 kg/m

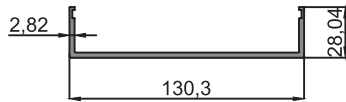

- 10-10538
- Ayak Kapak Profili L / Counterfort Cover Profile L
- 1.312 kg/m

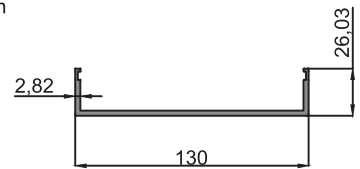

- 10-10057
- Oluk Profili / Gutter Profile
- 5.704 kg/m

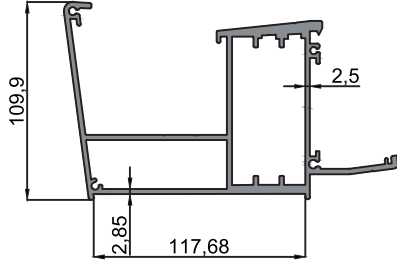

- 10-10059
- Duvar Profili / Wall Profile
- 1.983 kg/m

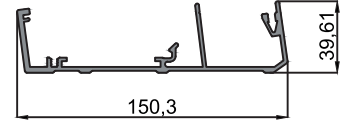

- 10-10060
- Duvar ve Oluk Profili Kapağı/Wall and Gutter Profile Cover
- 0.744 kg/m

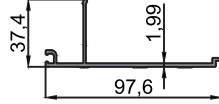

- 10-10058
- Taşıyıcı Profil/Carrier Profile
- 3.140 kg/m

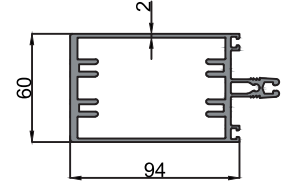

- 10-10062
- Taşıyıcı Profil Orta Kapağı / Carrier Profile Middle Cover
- 0.557 kg/m

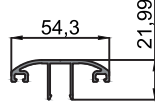

- 10-10061
- Taşıyıcı Profil Yan Kapağı / Carrier Profile Side Cover
- 0.754 kg/m

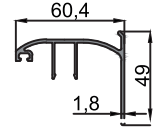

- 10-10103
- Ayak Profili / Counterfort Profile
- 3.352 kg/m

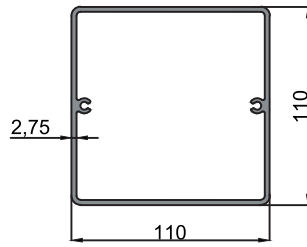

- 10-10102
- İç Bağlantı Profili/Internal Connecting Profile
- 2.481 kg/m

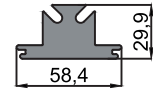

- 10-10448
- Oluk Profili / Gutter Profile
- 4.930 kg/m

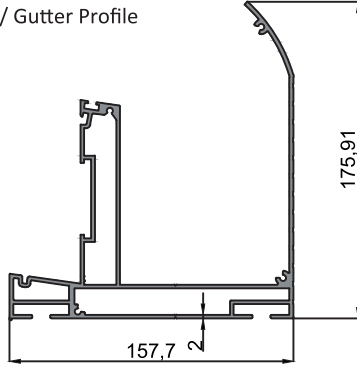

- 10-10450
- Duvar Profili / Wall Profile
- 2.572 kg/m

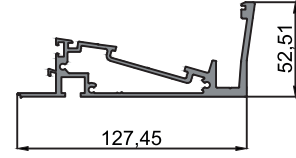

- 10-10454
- Duvar Baskı Profili / Wall Crush Profile
- 0.787 kg/m

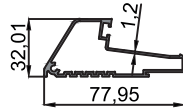

- 10-10455
- Oluk ve Duvar Profili Kapağı / Gutter and Wall Cover Profile
- 0.544 kg/m

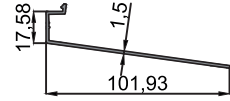

- 10-10451
- Cam Taşıyıcı Profil / Glazing Carrier Profile
- 2.362 kg/m

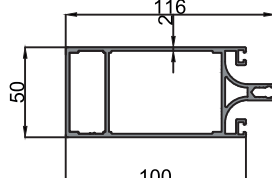

- 10-10452
- Cam Tutucu Profil / Glazing Stop Profile
- 0.436 kg/m

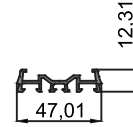

- 10-10456
- Cam Tutucu Orta Kapak Profili / Glazing Stop Middle Cover Profile
- 0.290 kg/m

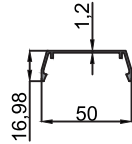

- 10-10457
- Cam Tutucu Yan Kapak Profili / Glazing Stop Side Cover Profile
- 0.436 kg/m

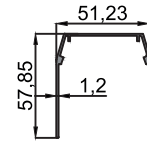

- 10-10453
- Ayak Profili / Counterfort Profile
- 3.117 kg/m

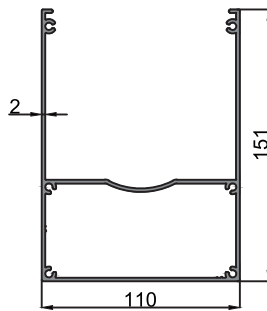

- 10-10449
- Ayak Kapak Profili / Counterfort Cover Profile
- 0.563 kg/m

